

# Wood Wood Casement Windows Replacement Parts



## Table of Contents

Exploded View .....	248
Parts List .....	249
Subsill, Brickmoulds and Stops .....	250 - 254
Glass Bead and Miscellaneous .....	255
Glass .....	256 - 258
Sash Assembly .....	259 - 260
Insulating Sash .....	259
Low-E Sash .....	259
Low-E Climate Control Sash .....	259
Low-E Sun Blocker Sash .....	259
Low-E Super Sun Blocker Sash .....	259
Picture Sash .....	260
Hardware/Miscellaneous .....	261 - 265
Casement Hardware .....	261
Arch Casement Hardware .....	262
Fastener Schedule .....	263
Weatherstripping/Miscellaneous .....	263
DLX Casement Hardware .....	264 - 265
DLX Fastener Schedule .....	265
Screens .....	266 - 267

### Exploded View

Wood Wood  
Casement Windows

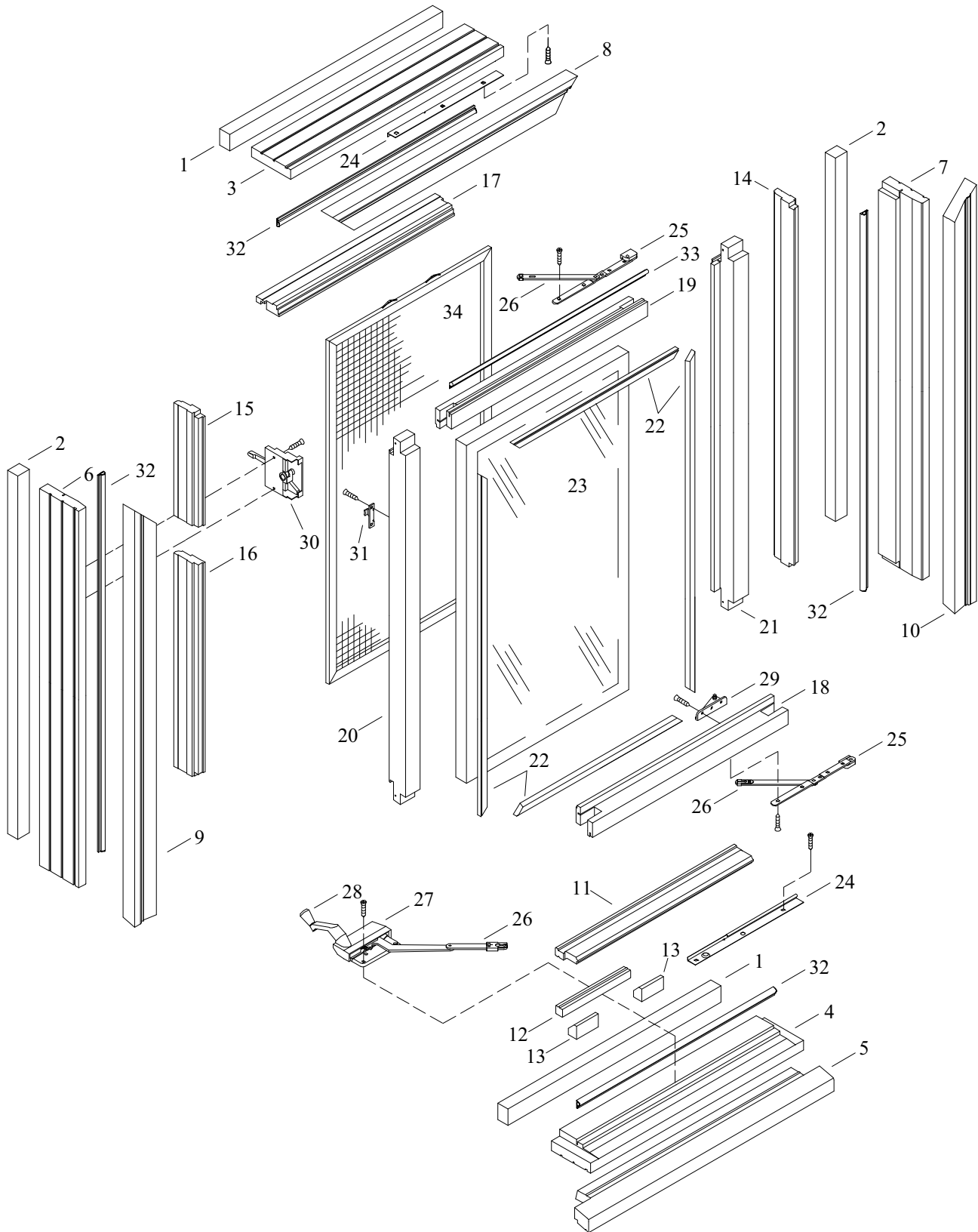

# Wood Wood Casement Windows Replacement Parts



## Parts List

Item No.	Description
1.	Head and Sill Extender
2.	Side Jamb Extender
3.	Head Jamb
4.	Sill
5.	Subsill
6.	Left Side Jamb
7.	Right Side Jamb
8.	Head Brickmould
9.	Left Side Brickmould
10.	Right Side Brickmould
11.	Sill Stop
12.	Sill Stop - Lower Section
13.	Sill Stop Blocks
14.	Hingeside Stop
15.	Lockside Stop (Top)
16.	Lockside Stop (Bottom)
17.	Head Stop
18.	Bottom Rail
19.	Top Rail
20.	Left Stile
21.	Right Stile
22.	Glass Bead (3/4" Insulating)
23.	3/4" Insulating Glass
24.	Hinge Track
25.	Hinge Arm
26.	Hinge Clip
27.	Split Arm Operator
28.	Roto Crank Handle
29.	Sash Bracket
30.	Sash Lock
31.	Keeper
32.	Foam Weatherstrip (Frame)
33.	Foam Weatherstrip (Sash)
34.	Screen (Fiberglass Mesh)

Subsill, Brickmoulds and Stops

Wood Wood  
Casement Windows

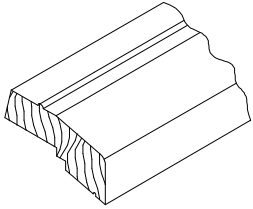

Item #5

Subsill	Part No.
11 CSE Subsill	206508
15 CSE Subsill	203097
19 CSE Subsill	203098
23 CSE Subsill	203099
27 CSE Subsill	203100
11 CSE Twin Subsill	206534
15 CSE Twin Subsill	203101
19 CSE Twin Subsill	203102
23 CSE Twin Subsill	203103
27 CSE Twin Subsill	203104
11 CSE Triple Subsill	206535
15 CSE Triple Subsill	204001
19 CSE Triple Subsill	204003
23 CSE Triple Subsill	204005
31 CSE Picture Subsill	203641
35 CSE Picture Subsill	203105
43 CSE Picture Subsill	203106
47 CSE Picture Subsill	203107
55 CSE Picture Subsill	203108
67 CSE Picture Subsill	203109
L/F Subsill	200961

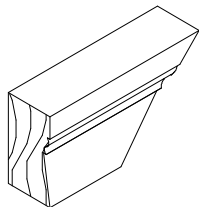

Item #8

Head Brickmould	Part No.
11 CSE Head Brickmould	206507
15 CSE Head Brickmould	203084
19 CSE Head Brickmould	203085
23 CSE Head Brickmould	203086
27 CSE Head Brickmould	203087
11 CSE Twin Head Brickmould	206542
15 CSE Twin Head Brickmould	203088
19 CSE Twin Head Brickmould	203089
23 CSE Twin Head Brickmould	203090
27 CSE Twin Head Brickmould	203091
11 CSE Triple Head Brickmould	206543
15 CSE Triple Head Brickmould	203995
19 CSE Triple Head Brickmould	203997
23 CSE Triple Head Brickmould	203999
31 CSE Picture Head Brickmould	203640
35 CSE Picture Head Brickmould	203092
43 CSE Picture Head Brickmould	203093
47 CSE Picture Head Brickmould	203094
55 CSE Picture Head Brickmould	203095
67 CSE Picture Head Brickmould	203096
L/F Brickmould	200957

Note: Parts drawings not to scale.

Note: When ordering stops, please note that stops manufactured after January 5, 2004 are shorter due to the change to 5/4 jamb. Sept/2004 March/2009

# Wood Wood Casement Windows *Hurd* Replacement Parts *Windows and Doors*

## Subsill, Brickmoulds and Stops

### Item #9

Left Side Brickmould	Part No.
27 CSE Left Side Brickmould	203070
31 CSE Left Side Brickmould	203071
35 CSE Left Side Brickmould	203072
43 CSE Left Side Brickmould	203073
47 CSE Left Side Brickmould	203074
55 CSE Left Side Brickmould	203075
59 CSE Left Side Brickmould	203354
67 CSE Left Side Brickmould	203076
L/F Brickmould	200957

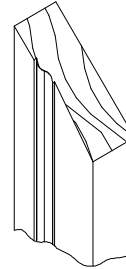

### Item #10

Right Side Brickmould	Part No.
27 CSE Right Side Brickmould	203077
31 CSE Right Side Brickmould	203078
35 CSE Right Side Brickmould	203079
43 CSE Right Side Brickmould	203080
47 CSE Right Side Brickmould	203081
55 CSE Right Side Brickmould	203082
59 CSE Right Side Brickmould	203355
67 CSE Right Side Brickmould	203083
L/F Brickmould	200957

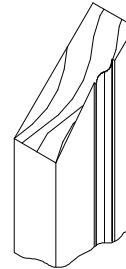

Exterior Mull Casing (Not Shown)	Part No.
27 CSE Exterior Mull Casing	203110
31 CSE Exterior Mull Casing	203111
35 CSE Exterior Mull Casing	203112
43 CSE Exterior Mull Casing	203113
47 CSE Exterior Mull Casing	203114
55 CSE Exterior Mull Casing	203115
59 CSE Exterior Mull Casing	203434
67 CSE Exterior Mull Casing	203116
L/F CSE Exterior Mull Casing-Vertical	203348

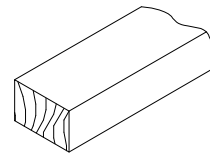

### Item #11

Operating Sill Stop	Part No.
11 CSE Operating Sill Stop	206503
15 CSE Operating Sill Stop	203028
19 CSE Operating Sill Stop	203029
23 CSE Operating Sill Stop	203030
27 CSE Operating Sill Stop	203031
31 CSE Operating Sill Stop	207475

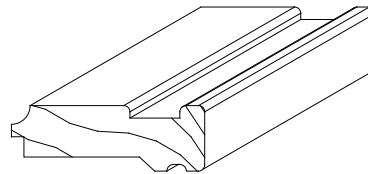

### Item #11

Operating DLX Sill Stop	Part No.
11 ACSE DLX Sill Cover	207278
15 ACSE DLX Sill Cover	207279
19 ACSE DLX Sill Cover	207280
23 ACSE DLX Sill Cover	207281
27 ACSE DLX Sill Cover	207282
31 ACSE DLX Sill Cover	207283

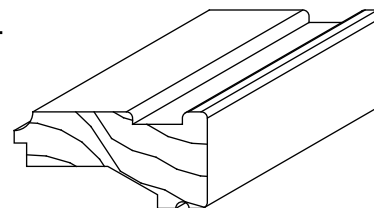

Note: Parts drawings not to scale.

Note: When ordering stops, please note that stops manufactured after January 5, 2004 are shorter due to the change to 5/4 jamb.

## Subsill, Brickmoulds and Stops

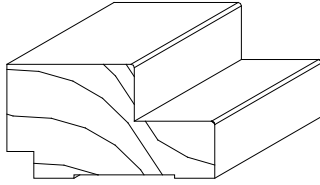

**Stationary Head and Sill Stop (Not Shown) Part No.**

11 CSE Stationary Head and Sill Stop	206505
15 CSE Stationary Head and Sill Stop	203037
19 CSE Stationary Head and Sill Stop	203038
23 CSE Stationary Head and Sill Stop	203039
27 CSE Stationary Head and Sill Stop	203040
31 CSE Stationary Head and Sill Stop	203041
35 CSE Stationary Head and Sill Stop	203042
43 CSE Stationary Head and Sill Stop	203043
47 CSE Stationary Head and Sill Stop	203044
55 CSE Stationary Head and Sill Stop	203045
59 CSE Stationary Head and Sill Stop	203634
67 CSE Stationary Head and Sill Stop	203046

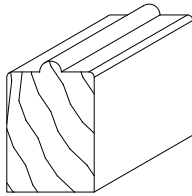

**Item #12 Standard DLX  
Sill Stop (Lower Section) Part No. Part No.**

11 CSE Lower Sill Stop - Lockside	206504	207464
11 CSE Lower Sill Stop - Hingeside	203231	207463
15 CSE Lower Sill Stop - Lockside	203032	207465
15 CSE Lower Sill Stop - Hingeside	203231	207463
19 CSE Lower Sill Stop - Lockside	203033	207466
19 CSE Lower Sill Stop - Hingeside	203231	207463
23 CSE Lower Sill Stop - Lockside	203034	207467
23 CSE Lower Sill Stop - Hingeside	203231	207463
27 CSE Lower Sill Stop - Lockside	203035	207468
27 CSE Lower Sill Stop - Hingeside	203231	207463
31 CSE Lower Sill Stop - Lockside	N/A	207469
31 CSE Lower Sill Stop - Hingeside	N/A	207463

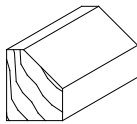

**Item #13 Standard DLX  
Sill Stop Block (2 Pcs./Operating Unit) Part No. Part No.**

CSE Sill Stop Block, each	203644	207084
L/F CSE Sill Stop Block	203124	207083

**Item #14 Hingeside Stop Part No.**

27 CSE Hingeside Stop	203017
31 CSE Hingeside Stop	203018
35 CSE Hingeside Stop	203019
43 CSE Hingeside Stop	203020
47 CSE Hingeside Stop	203021
55 CSE Hingeside Stop	203022
59 CSE Hingeside Stop	203353
67 CSE Hingeside Stop	203023

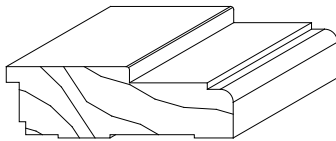

Note: Parts drawings not to scale.

Note: When ordering stops, please note that stops manufactured after January 5, 2004 are shorter due to the change to 5/4 jamb.

# Wood Wood Casement Windows Replacement Parts



## Subsill, Brickmoulds and Stops

Items #15 & #16 Lockside Stops (LH Operating Units)	Standard Part No.	DLX Part No.
27 CSE Lockside Stop - Top Section	203016	207439
27 CSE Lockside Stop - Bottom Section	203013	
31 CSE Lockside Stop - Top Section	203016	207440
31 CSE Lockside Stop - Bottom Section	203014	
35 CSE Lockside Stop - Top Section	203016	207441
35 CSE Lockside Stop - Bottom Section	203015	
43 CSE Lockside Stop - Top Section	203012	207442
43 CSE Lockside Stop - Middle Section	203303	
43 CSE Lockside Stop - Bottom Section	203016	
47 CSE Lockside Stop - Top Section	203012	207443
47 CSE Lockside Stop - Middle Section	203304	
47 CSE Lockside Stop - Bottom Section	203016	
55 CSE Lockside Stop - Top Section	203012	207444
55 CSE Lockside Stop - Middle Section	203305	
55 CSE Lockside Stop - Bottom Section	203016	
59 CSE Lockside Stop - Top Section	203012	207445
59 CSE Lockside Stop - Middle Section	203356	
59 CSE Lockside Stop - Bottom Section	203016	
67 CSE Lockside Stop - Top Section	203012	207446
67 CSE Lockside Stop - Middle Section	203306	
67 CSE Lockside Stop - Bottom Section	203016	

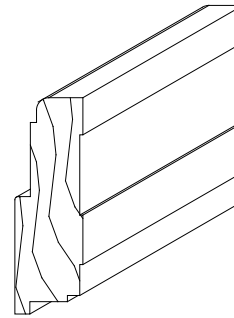

Standard

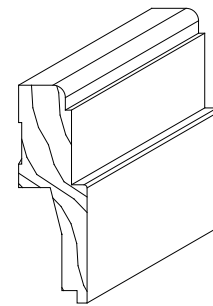

Deluxe

Items #15 & #16 Lockside Stops (RH Operating Units)	Standard Part No.	DLX Part No.
27 CSE Lockside Stop - Top Section	203012	207447
27 CSE Lockside Stop - Bottom Section	203009	
31 CSE Lockside Stop - Top Section	203012	207448
31 CSE Lockside Stop - Bottom Section	203010	
35 CSE Lockside Stop - Top Section	203012	207449
35 CSE Lockside Stop - Bottom Section	203011	
43 CSE Lockside Stop - Top Section	203016	207450
43 CSE Lockside Stop - Middle Section	203303	
43 CSE Lockside Stop - Bottom Section	203012	
47 CSE Lockside Stop - Top Section	203016	207451
47 CSE Lockside Stop - Middle Section	203304	
47 CSE Lockside Stop - Bottom Section	203012	
55 CSE Lockside Stop - Top Section	203016	207452
55 CSE Lockside Stop - Middle Section	203305	
55 CSE Lockside Stop - Bottom Section	203012	

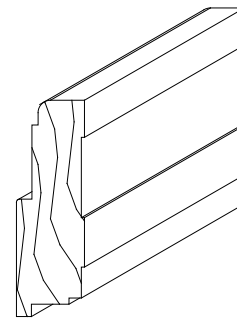

Standard

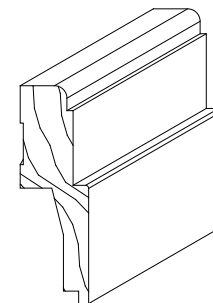

Deluxe

Note: Parts drawings not to scale.

Note: When ordering stops, please note that stops manufactured after January 5, 2004 are shorter due to the change to 5/4 jamb.

Continued on next page

**Subsill, Brickmoulds and Stops**

Continued from previous page

Wood Wood  
Casement Windows

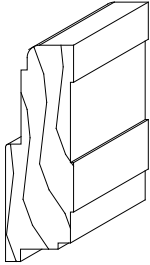

Items #15 & #16 Lockside Stops (RH Operating Units)	Standard Part No.	DLX Part No.
59 CSE Lockside Stop - Top Section	203016	207453
59 CSE Lockside Stop - Middle Section	203356	
59 CSE Lockside Stop - Bottom Section	203012	
67 CSE Lockside Stop - Top Section	203016	207454
67 CSE Lockside Stop - Middle Section	203306	
67 CSE Lockside Stop - Bottom Section	203012	

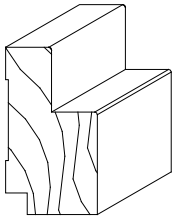

Stationary Side Stops (Not Shown, 2 per Unit)	Part No.
11 CSE Stationary Side Stops	205862
15 CSE Stationary Side Stops	204539
19 CSE Stationary Side Stops	203646
23 CSE Stationary Side Stops	203994
27 CSE Stationary Side Stops	203047
31 CSE Stationary Side Stops	203048
35 CSE Stationary Side Stops	203049
43 CSE Stationary Side Stops	203050
47 CSE Stationary Side Stops	203051
55 CSE Stationary Side Stops	203052
59 CSE Stationary Side Stops	203350
67 CSE Stationary Side Stops	203053

**Item #17**

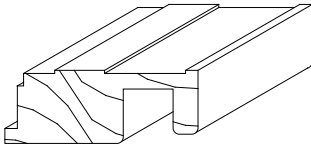

Head Stop (Operating Units)	Part No.
11 CSE Operating Head Stop	207476
15 CSE Operating Head Stop	207477
19 CSE Operating Head Stop	207478
23 CSE Operating Head Stop	207479
27 CSE Operating Head Stop	207480
31 CSE Operating Head Stop	207481

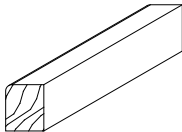

Stationary Sash Block (Not Shown, 2 per Head and Sill)	Part No.
L/F CSE Stationary Sash Block	206497

Lockside Support Block - DLX	Part No.
L/F Lockside Support Block - DLX only	207778

Note: When ordering stops, please note that stops manufactured after January 5, 2004 are shorter due to the change to 5/4 jamb.

Note: Parts drawings not to scale.

# Wood Wood Casement Windows Replacement Parts



## Glass Bead and Miscellaneous

Item #22

Glass Bead - 3/4" Insulating Glass Part No.

L/F Insulating Wood Glass Bead (3 MM and 4 MM) 203125

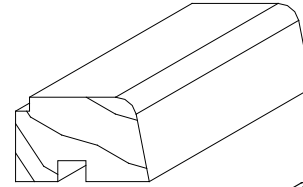

Wood Glazing Bead

CSE 1" White Vinyl Glaze Bead 014518

CSE 1" Tan Vinyl Glaze Bead 035028

Flex Molding (Arch Casement) 010293

Elastomeric sealant - 10 oz. tube  
(Used between glass and wood on the interior and exterior face of the glass) 019305

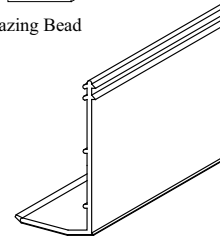

Vinyl Glazing Bead

Wood Wood Casement Windows

### Cutting Schedule - Rails and Stiles (45° Cut as follows)

Rails (2 ea.)				Stiles (2 ea.)			
11" Glass	11-9/32"	35" Glass	35-9/32"	27" Glass	27-9/32"	47" Glass	47-9/32"
15" Glass	15-9/32"	43" Glass	43-9/32"	31" Glass	31-9/32"	55" Glass	55-9/32"
19" Glass	19-9/32"	47" Glass	47-9/32"	35" Glass	35-9/32"	59" Glass	59-9/32"
23" Glass	23-9/32"	55" Glass	55-9/32"	43" Glass	43-9/32"	67" Glass	67-9/32"
27" Glass	27-9/32"	67" Glass	67-9/32"				
31" Glass	31-9/32"						

Tech Tip: All rails and stiles are now 3/4" common air glass.

Snubber (Not Shown) Part No.

CSE Snubber (includes two (2) #7x3/4" FH Screws) 010475

Note: 43" Glass height and above require one (1) Snubber centered on hingeside only.

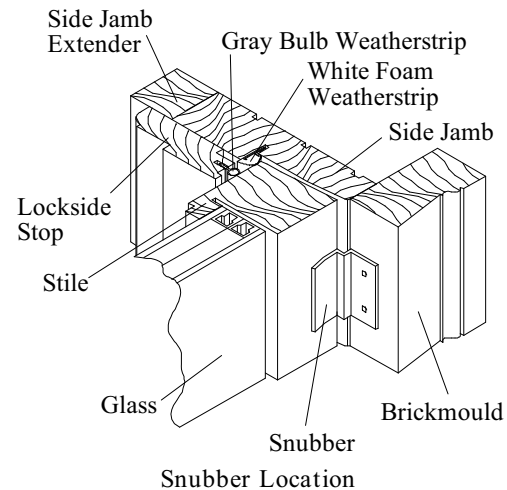
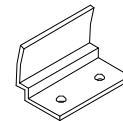

Note: Parts drawings not to scale.

**Glass**

Item #23 Glass

Glass Size	3 MM Insulating Part No.	Standard 3 MM Low-E Part No.	3 MM Low-E	
			Climate Control **	Super ** Sun Blocker
11 x 27	515041	517591		
11 x 31	515042	517592		
11 x 35	515043	517593		
11 x 43	515044	517594		
11 x 47	515045	517689		
11 x 55	515046	517690		
11 x 59*	515047	517691		
11 x 67*	515860	521347		
15 x 27	511350	517598		
15 x 31	511351	517599		
15 x 35	511352	517600		
15 x 43	511353	517601		
15 x 47	511354	517692		
15 x 55	511355	517693		
15 x 59	511503	517694		
15 x 67	511356	517695		
19 x 19	511495	517602		
19 x 23	512275	517603		
19 x 27	511357	517604		
19 x 31	511358	517605		
19 x 35	511359	517606		
19 x 43	511360	517606		
19 x 47	511361	517724		
19 x 55	511362	517725		
19 x 59	511504	517726		
19 x 67	511363	517727		
23 x 23	512276	517608		
23 x 27	511364	517609		
23 x 31	511365	517610		
23 x 35	511366	517611		
23 x 43	511367	517612		
23 x 47	511368	517696		
23 x 55	511369	517697		
23 x 59	511505	517698		
23 x 67	511370	517699		
27 x 27	511371	517613		
27 x 31	511372	517614		
27 x 35	511373	517615		
27 x 43	511374	517616		
27 x 47	511375	517700		
27 x 55	511376	517701		
27 x 59	511506	517702		
27 x 67	511377	517703		

\* Glass must be tempered.

\*\* Climate Control and Super Sun Blocker do not have part numbers.

Tech Tip: Hurd recommends glass only for replacement.

Wood Wood  
Casement Windows

# Wood Wood Casement Windows Replacement Parts



## Picture Glass

### Item #23 Glass

Glass Size	3 MM Insulating		Standard 3 MM Low-E	
	Part No.	Part No.	3 MM Low-E	
			Climate Control **	Super Sun Blocker **
31 x 31	511496	517617		
31 x 35	511497	517618		
31 x 43	511802	517619		
31 x 47	511803	517704		
31 x 55	511804	517705		
31 x 59	511805	517706		
31 x 67*	511806	517707		
35 x 31	511497	517618		
35 x 35	511480	517708		
35 x 43	511481	517620		
35 x 47	511482	517709		
43 x 31	511802	517619		
43 x 35	511481	517620		
43 x 43	511485	517713		
47 x 31	511803	517704		
47 x 35	511482	517709		
55 x 31	511804	517705		
59 x 31	511805	517706		
67 x 31*	511806	517707		

\* Glass must be tempered.

\*\* Climate Control and Super Sun Blocker do not have part numbers.

Tech Tip: Hurd recommends glass only for replacement.

**Picture Glass**

**Item #23 Glass**

(Used in windows manufactured after February 19, 2003)

Glass Size	4 MM Insulating	Standard 4 MM Low-E	4 MM Low-E	
	Part No.	Part No.	Climate Control**	Super Sun Blocker**
35 x 55	511483	517710		
35 x 59	511507	517711		
35 x 67	511484	517712		
43 x 47	511486	517714		
43 x 55	511487	517715		
43 x 59	511508	517716		
43 x 67*	511488	517717		
47 x 43	511486	517714		
47 x 47	511489	517718		
47 x 55	511490	517719		
47 x 59	511509	517720		
47 x 67*	511491	517721		
55 x 35	511483	517710		
55 x 43	511487	517715		
55 x 47	511490	517719		
55 x 55*	511492	517722		
55 x 59*	511510	517723		
55 x 67	511493	517686		
59 x 35	511507	517711		
59 x 43	511508	517716		
59 x 47	511509	517720		
59 x 55*	511510	517723		
67 x 35	511484	517712		
67 x 43*	511488	517717		
67 x 47*	511491	517721		

Glass Size	5 MM Insulating	Standard 5 MM Low-E	5 MM Low-E	
	Part No.	Part No.	Climate Control**	Super Sun Blocker**
59 x 59*	511722	522917		
59 x 67*	511511	517687		
67 x 55*	511493	517686		
67 x 59*	511511	517687		
67 x 67*	511494	517688		

\* Glass must be tempered.

\*\* Climate Control and Super Sun Blocker do not have part numbers.

Tech Tip: Hurd recommends glass only for replacement.

Wood Wood  
Casement Windows

# Wood Wood Casement Windows Replacement Parts



## Sash Assembly

Glass Size	Basic Unit Size	Insulating	Low-E		
			Standard	Climate Control	Super Sun Blocker
11 x 27	15-11/16 x 31-11/16				
11 x 31	15-11/16 x 35-11/16				
11 x 35	15-11/16 x 39-11/16				
11 x 43	15 11/15 x 47-11/16				
11 x 47	15-11/16 x 51-11/16				
11 x 55	15-11/16 x 59-11/16				
11 x 59*	15-11/16 x 63-11/16				
11 x 67*	15-11/16 x 71-11/16				
15 x 19	19-11/16 x 23-11/16				
15 x 23	19-11/16 x 27-11/16				
15 x 27	19-11/16 x 31-11/16				
15 x 31	19-11/16 x 35-11/16				
15 x 35	19-11/16 x 39-11/16				
15 x 43	19 11/15 x 47-11/16				
15 x 47	19-11/16 x 51-11/16				
15 x 55	19-11/16 x 59-11/16				
15 x 59	19-11/16 x 63-11/16				
15 x 67	19-11/16 x 71-11/16				
19 x 19	23-11/16 x 23-11/16				
19 x 23	23-11/16 x 27-11/16				
19 x 27	23-11/16 x 31-11/16				
19 x 31	23-11/16 x 35-11/16				
19 x 35	23-11/16 x 39-11/16				
19 x 43	23 11/15 x 47-11/16				
19 x 47	23-11/16 x 51-11/16				
19 x 55	23-11/16 x 59-11/16				
19 x 59	23-11/16 x 63-11/16				
19 x 67	23-11/16 x 71-11/16				
23 x 23	27-11/16 x 27-11/16				
23 x 27	27-11/16 x 31-11/16				
23 x 31	27-11/16 x 35-11/16				
23 x 35	27-11/16 x 39-11/16				
23 x 43	27 11/15 x 47-11/16				
23 x 47	27-11/16 x 51-11/16				
23 x 55	27-11/16 x 59-11/16				
23 x 59	27-11/16 x 63-11/16				
23 x 67	27-11/16 x 71-11/16				
27 x 27	31-11/16 x 31-11/16				
27 x 31	31-11/16 x 35-11/16				
27 x 35	31-11/16 x 39-11/16				
27 x 43	31 11/15 x 47-11/16				
27 x 47	31-11/16 x 51-11/16				
27 x 55	31-11/16 x 59-11/16				
27 x 59	31-11/16 x 63-11/16				
27 x 67	31-11/16 x 71-11/16				
31 x 31	35-11/16 x 35-11/16				
31 x 35	35-11/16 x 39-11/16				
31 x 43	35 11/15 x 47-11/16				
31 x 47	35-11/16 x 51-11/16				
31 x 55	35-11/16 x 59-11/16				
31 x 59	35-11/16 x 63-11/16				
31 x 67*	35-11/16 x 71-11/16				

\* Glass must be tempered.

Tech Tip: Sash size = Glass size + 2-15/16

Wood Wood Casement Windows

**Picture Sash Assembly**

Picture Sash

Glass Size	Basic Unit Size	Insulating	Low-E		
			Standard	Climate Control	Super Sun Blocker
35 x 31	39-11/16 x 35-11/16				
35 x 35	39-11/16 x 39-11/16				
35 x 43	39 11/15 x 47-11/16				
34 x 47	39-11/16 x 51-11/16				
35 x 55	39-11/16 x 59-11/16				
35 x 59	39-11/16 x 63-11/16				
35 x 67	39-11/16 x 71-11/16				
43 x 31	47-11/16 x 35-11/16				
43 x 35	47-11/16 x 39-11/16				
43 x 43	47 11/15 x 47-11/16				
43 x 47	47-11/16 x 51-11/16				
43 x 55	47-11/16 x 59-11/16				
43 x 59	47-11/16 x 63-11/16				
43 x 67	47-11/16 x 71-11/16				
47 x 31	51-11/16 x 35-11/16				
47 x 35	51-11/16 x 39-11/16				
47 x 43	51 11/15 x 47-11/16				
47 x 47	51-11/16 x 51-11/16				
47 x 55	51-11/16 x 59-11/16				
47 x 59	51-11/16 x 63-11/16				
47 x 67	51-11/16 x 71-11/16				
55 x 31	59-11/16 x 35-11/16				
55 x 35	59-11/16 x 39-11/16				
55 x 43	59 11/15 x 47-11/16				
55 x 47	59-11/16 x 51-11/16				
55 x 55	59-11/16 x 59-11/16				
55 x 59	59-11/16 x 63-11/16				
55 x 67	59-11/16 x 71-11/16				
59 x 31	63-11/16 x 35-11/16				
59 x 35	63-11/16 x 39-11/16				
59 x 43	63 11/15 x 47-11/16				
59 x 47	63-11/16 x 51-11/16				
59 x 55	63-11/16 x 59-11/16				
59 x 59	63-11/16 x 63-11/16				
59 x 67	63-11/16 x 71-11/16				
67 x 31	71-11/16 x 35-11/16				
67 x 35	71-11/16 x 39-11/16				
67 x 43	71 11/15 x 47-11/16				
67 x 47	71-11/16 x 51-11/16				
67 x 55	71-11/16 x 59-11/16				
67 x 59	71-11/16 x 63-11/16				
67 x 67	71-11/16 x 71-11/16				

Tech Tip: Sash size = Glass size + 2-15/16

# Wood Wood Casement Windows Replacement Parts



## Hardware/Miscellaneous

Items #24 - #31

### Casement Hardware

(For units manufactured prior to May 3, 2004)

Item No.	Description	Part No.	
		Left	Right
24	CSE Hinge Track	092994	092995
25	CSE Hinge (11, 15, 19, 27)*	015221	015222
	CSE Hinge (23 Egress)*	015219	015220
26	CSE Hinge Clip	019014	
<del>27</del>	<del>CSE Split Arm Operator* - Gold Tone</del>	<del>015196</del>	<del>015197</del>
	<del>CSE Split Arm Operator - White</del>	<del>018909</del>	<del>018910</del>
	<del>CSE Split Arm Operator - 03 Bronze</del>	<del>091692</del>	<del>091693</del>
28	CSE Roto Crank Handle - Gold Tone	010768	
	CSE Roto Crank Handle - White	010769	
	CSE Roto Crank Handle - 03 Bronze	090934	
Not Shown	CSE Folding Operating Handle - Gold Tone	037188	
	CSE Folding Operating Handle - White	037189	
	CSE Folding Operating Handle - 03 Bronze	091691	
29	CSE Sash Bracket*	015198	015199
30	CSE Handed Sash Lock - Gold Tone	016155	016156
	CSE Handed Sash Lock - White	018911	018912
	CSE Handed Sash Lock - 03 Bronze	091694	091695
31	CSE Keeper (Non-Handed)	010526	
Not Shown	CSE Snubber	010475	

No longer available

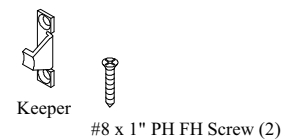
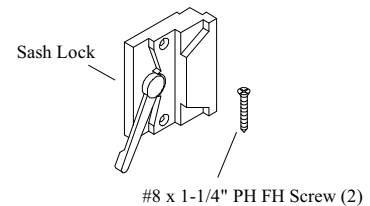
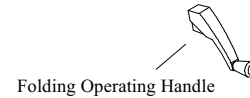
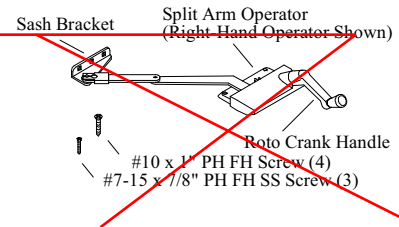
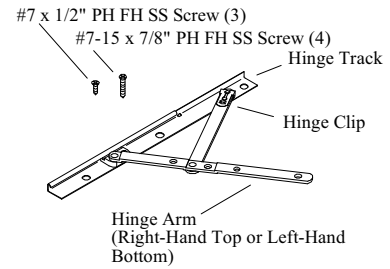

For DLX hardware, refer to pages 264 - 265.

\*Black Powder Painted Finish

Note: Parts drawings not to scale.

**Hardware/Miscellaneous**

**Arch Casement Hardware**  
(For units manufactured prior to May 3, 2004)

Item No.	Description	Part No.	
		Left	Right
	11, 15 Glass Size:		
Not Shown	DLX Short Single Arm Operator - Gold	035890	035891
	DLX Short Single Arm Operator - White	035894	035895
	19, 23, 27, 31 Glass Size:		
Not Shown	Single Arm Operator - Gold	035888	035889
	Single Arm Operator - White	035892	035893
Not Shown	CSE Sash Track		010203

**Arch Casement Hardware**  
Current (Effective May 3, 2004)

Item No.	Description	Part No.	
		Left	Right
	11, 15 Glass Size:		
Not Shown	DLX Short Single Arm Operator* - Gold	093648	093649
	DLX Short Single Arm Operator* - White	093650	093651
	DLX Short Single Arm Operator* - 03 Bronze	093652	093653
	DLX Short Single Arm Operator* - Bright Brass	093654	093655
	19, 23, 27, 31 Glass Size:		
Not Shown	Single Arm Operator* - Gold	093656	093657
	Single Arm Operator* - White	093658	093659
	Single Arm Operator* - 03 Bronze	093660	093661
	Single Arm Operator* - Bright Brass	093662	093663
Not Shown	CSE Butt Hinges (Stainless Steel)	039502	039503
Not Shown	CSE Sash Track*		010730
Not Shown	CSE Track Shoe		011789

\*Black Powder Painted Finish

# Wood Wood Casement Windows Replacement Parts



## Hardware/Miscellaneous

### Fastener Schedule

Description	Where Used	Qty.	Part No.
#7 x 7/8" TOYO PH FH SS Screw	Hinge track to head and sill.	6	013804
#7 x 7/8" PH FH PBS STL Dorken Screw	Hinges to top and bottom rail.	7	099285
#7 x 7/8" PH FH PBS STL Dorken Screw	Sash bracket to bottom rail.	3	099285
#7 x 7/8" PH FH PBS STL Dorken Screw	Operator to sill.	6	099285
#8 x 1-1/4" PH FH SM Z&Y Screw	Sash lock to frame.	2 or 4	011965
#6 x 1 1/4" PH FH WD Z&Y Screw	Subsill to Sill	2-4	010607
#8 x 1 3/4" PH FH Screw	Head Board to Jamb	5"-8" Spacing	011205
#8 x 2" PH FH Zinc Screw	Seat Board to Jamb	5"-8" Spacing	010785
#6 x 2 3/4" PH FH WD Z&Y Screw	Picture Sash to Frame	As Required	011836
#6 x 2 3/4" PH FH WD Z&Y Screw	Screw Sash Corners Thru Tenon	4	011836
#6 x 5/8" PH Truss HD Screw	Limit Device Slide to Sash	2	085425
#7 x 1/2" PH FL 100 Degree Head SS	Limit Device to Frame	2	013801
#7 x 7/8" PH FH PBS STL Dorken Screw	Keeper to stile.	2	099285
#6 x 2-3/4" PH FH Screw	Stationary stops to sash.	As Req'd.	011836
#6 Brass Finishing Washer	Used w/#6 x 2 3/4" screw.	As Req'd.	011835
"C" Hinge Shim	Service item - installed between bottom hinge and sash or bottom track and frame.	As Req'd.	015511
Keeper Locator	Service item.	1	025685



### Items #32 - #33

### Weatherstripping/Miscellaneous

Item No.	Description	Where Used	Part No.
32	L/F White Foam Weatherstrip	Casement Frame: Head, Sill, Side Jambs	015201
	L/F Bronze Foam Weatherstrip		097826
33	L/F White Foam Weatherstrip	Casement Sash: Top Rail Only	019923
	L/F Bronze Foam Weatherstrip		019924
Not Shown	Screen Corner Key - White	Lift rail	094576
Not Shown	Screen Corner Key - Bronze	Lift rail	094577
Not Shown	Screen Corner Key - Gold	Lift rail	094575
Not Shown	Plunger and DH Concealed Screen Corner Key		094578

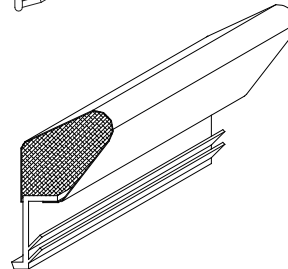
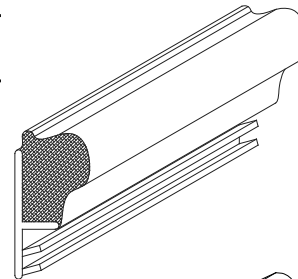

Note: Parts drawings not to scale.

### Hardware/Miscellaneous

Items #24 - #29

DLX Casement Hardware\*\*

Current (Effective May 3, 2004)

Wood Wood Casement Windows

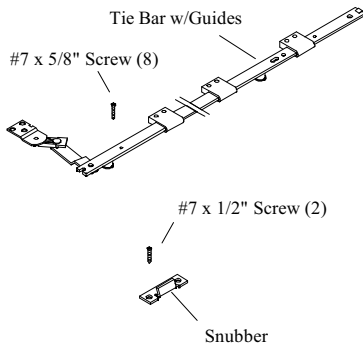
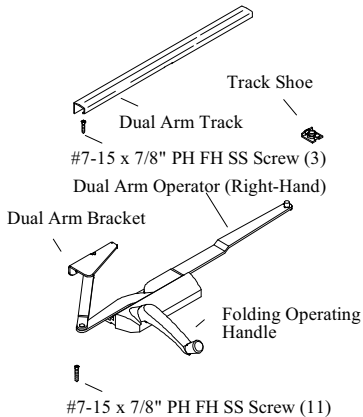
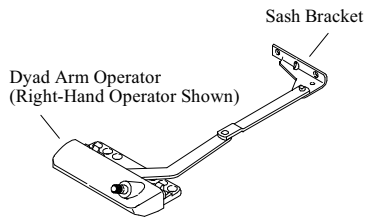
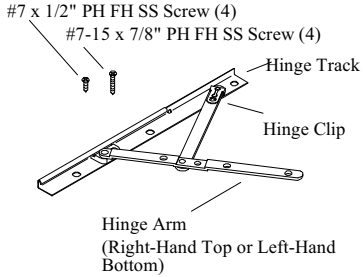

Item No.	Description	Part No.	
		Left	Right
24	CSE Hinge Track (23 Egress only)	092994	092995
	CSE Hinge Track (11, 15, 19, 23, 27, 31)*	071153	071154
25	CSE Hinge (23 Egress only)*	010784	010786
	CSE Hinge (11, 15, 19, 23, 27, 31)	010787	010793
26	CSE Hinge Clip (23 Egress only)		019014
	CSE Hinge Clip (DLX)		076005
27	CSE Dyad Arm Operator* - Gold Tone (11, 15 width)	010731	010732
	CSE Dyad Arm Operator* - 03 Bronze (11, 15 width)	090935	090936
	CSE Dyad Arm Operator* - White (11, 15 width)	010733	010734
	CCSE Dyad Arm Operator* - Bright Brass (11, 15 width)	010735	010736
27	CSE Dual Arm Operator* - Gold Tone	010723	010722
	CCSE Dual Arm Operator* - 03 Bronze	090937	090938
	CSE Dual Arm Operator* - White	010724	010725
	CSE Dual Arm Operator* - Bright Brass	010726	010727
28	CSE Roto Crank Handle - Gold Tone		010768
	CSE Roto Crank Handle - 03 Bronze		090934
	CSE Roto Crank Handle - White		010769
	CSE Roto Crank Handle - Bright Brass		031951
	29	CSE Sash Bracket*	010729
Not Shown	CSE Dual Arm Track*		010730
Not Shown	CSE Dual Arm Track Shoe		011789
Not Shown	CSE Folding Operating Handle - Gold Tone		037188
Not Shown	CSE Folding Operating Handle - 03 Bronze		091691
Not Shown	CSE Folding Operating Handle - White		037189
Not Shown	CSE Folding Operating Handle - Bright Brass		030165
Not Shown	CCSE 19 & 23 Stainless Steel Tie Bar w/ Guide	093958	093959
	CCSE 27 Stainless Steel Tie Bar w/ Guide	093938	093939
	CCSE 31 Stainless Steel Tie Bar w/ Guide	093940	093941
	CCSE 35 Stainless Steel Tie Bar w/ Guide	093942	093943
	CCSE 43 Stainless Steel Tie Bar w/ Guide	093944	093945
	CCSE 47 Stainless Steel Tie Bar w/ Guide	093946	093947
	CCSE 55 Stainless Steel Tie Bar w/ Guide	093948	093949
	CCSE 59 Stainless Steel Tie Bar w/ Guide	093950	093951
	CCSE 67 Stainless Steel Tie Bar w/ Guide	093952	093953
Not Shown	CSE Snubber		010808
	35, 43-55 Unit Heights - 2 per unit		
	59 and 67 Unit Heights - 4 per unit		

Note: Parts drawings not to scale.

\*Black Powder Painted Finish

\*\* DLX Hardware is optional for Wood Wood products, and standard on 31" glass width.

# Wood Wood Casement Windows Replacement Parts







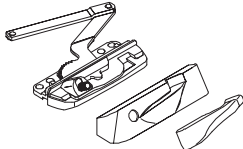
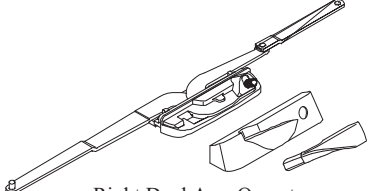

Notes:

- Encore hardware is interchangeable with DLX units.
- Fasteners are ordered separately, See page 15 for a complete list and part numbers.

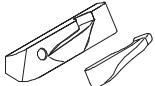
## Hardware / Miscellaneous

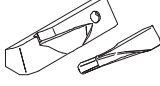
### Casement Hardware Encore (9/19/05 to Present)

Item No.	Description	Left	Part No.	Right
<b>11</b>	<u>CCSE Encore Dual Arm Operator</u>	096340		096341
<b>11</b>	<u>CCSE Encore Dyad Arm Operator (11, 15 width) With E-Gard Finish</u>	096338	096339	
	<u>CCSE Encore Reverse Dyad</u> For small speciality windows. With E-Gard Finish	096655		096654
				
	Left Dyad Operator with Right Operator Cover and Handle Package			
				
	Right Dyad Operator with Left Operator Cover and Handle Package			
				
	Right Dual Arm Operator with Left Operator Cover and handle Package			
Not Shown on Exploded Views	<u>Construction "T" Handle</u> Sept. 2006 to Present	097103		
				
<b>13</b>	<u>CCSE Sash Bracket - Encore &amp; DLX</u> For Dual Arm & Dyad Operator	096349	096350	
	<u>CCSE Sash Bracket - Split Arm</u>	015198	015199	
	<u>CCSE Bracket</u> Non-handad Reverse Dyad Operator Bracket		096656	
				
<b>12 &amp; 21</b>	<u>Encore Operator Cover and Handle Set Package</u>			
	Gold Tone	096357		
	White	096353		
	Bronze	096355		
	Bright Brass	096363		
	Antique Brass	096660		
	Oil-Rubbed Bronze	096359		
	Coppertone	096657		
	Champagne	096374		
	Brushed Nickel	096667		
	Brushed Chrome	096361		
	Polished Chrome	096665		
			<u>FOR:</u> <u>Left Dual Arm Operator</u> or <u>Right Dyad Operator</u>	
			<u>FOR:</u> <u>Right Dual Arm Operator</u> or <u>Left Dyad Operator</u>	
				
				
				

 Tech Tip: Encore cover and handles sold as sets only.



Note: When ordering replacement operators, note the configuration of left and right hand operators and their corresponding cover and handle packages. Take care that the correct cover and handle package is ordered with your operator.

Note: Parts drawings not to scale.

Hardware / Miscellaneous

Notes: Fasteners are ordered separately.

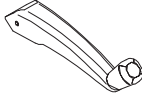
Handles used on DLX & Prior

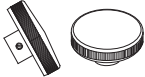
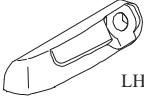
Not Shown on Exploded Views	<u>CCSE Truth Operator Crank Handle</u>				
	Gold Tone		010768		
	White		010769		
	Bronze		090934		
	Bright Brass		031951		
	Oil-Rubbed Bronze		095420		
	Brushed Chrome		095427		
Not Shown on Exploded Views	<u>CCSE Folding Operator Handle</u>				
	Gold Tone		037188		
	White		037189		
	Bronze		091691		
	Bright Brass		030165		
	Oil-Rubbed Bronze		094564		
	Brushed Chrome		094569		
Not Shown on Exploded Views	<u>Operator "T" Crank Handle</u>				
	Gold Tone		019915		
	White		021951		
	Bronze		092684		
	Bright Brass		031962		
Not Shown on Exploded Views	<u>Operator Hand Knob</u>				
	Gold Tone		021949		
	White		021950		
	Bronze		092427		
	Bright Brass		031961		
Not Shown on Exploded Views	<u>Operator Nesting Cover</u>		<u>LH Dyad RH</u>	<u>RH Dyad LH</u>	
	Gold Tone		095355	095356	
	White		095237	095238	
	Bronze		095239	095240	
	Oil-Rubbed Bronze		094563	094562	
	Brushed Chrome		094568	094567	

For use with DLX hardware only. Use with Folding Operator handle.

LH Shown  
(Matched Handing except  
11 & 15 which Use Opposite)

Note: Parts drawings not to scale.

# Wood Wood Casement Windows Replacement Parts



## Items #30 - #31 DLX Casement Hardware\*\* (cont'd)

## Hardware/Miscellaneous

Item No.	Description	Part #	
		Left	Right
30	<u>CSE Lever Lock Handle</u>		
	Gold Tone _____		096419
	White _____		010265
	Bronze _____		090933
	Bright Brass _____		010263
	Antique Brass _____		096448
	Oil-Rubbed Bronze _____		099808
	Coppertone _____		096447
	Champagne _____		096497
	Brushed Nickel _____		096449
	Brushed Chrome _____		094570
	Bright Chrome _____		096450
	<u>CSE Lock Escutcheon WITH Guard</u>		
	Gold Tone _____		099029
	White _____		099030
	Bronze _____		099032
	Bright Brass _____		099031
	Antique Brass _____		099034
	Oil-Rubbed Bronze _____		099810
	Coppertone _____		099033
	Champagne _____		099038
	Brushed Nickel _____		099035
	Brushed Chrome _____		099037
	Bright Chrome _____		099036

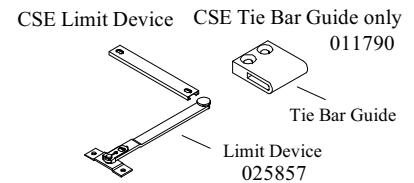
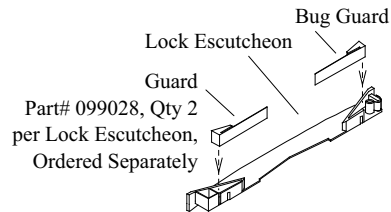

Item No.	Description	Part #	
		Left	Right
31	CSE Keeper*		
	27, 31, 35 Unit Heights - 1 per unit		
	43 and 47 Unit Heights - 2 per unit		
	55, 59, 67 Unit Heights - 3 per unit		
		010251	010252

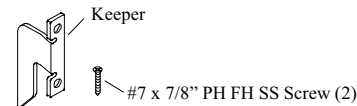

\*Black Powder Painted Finish

### DLX Fastener Schedule

Description	Where Used	Qty.	Part No.
#7 x 1/2" PH FH SS Screw	Hinge track to head and sill.	8	013801
#7-15 x 7/8" PH FH SS Screw	Hinges to top and bottom rail.	8	024516
#7 x 7/8" PH FH Black Screw	Dyad bracket to bottom rail.	2	011365
#7 x 7/8" PH FH Black Screw	Dual arm track to bottom rail.	3	011365
#7 x 7/8" PH FH Black Screw	Dual arm bracket to bottom rail	1	011365
#7-15 x 7/8" PH FH SS Screw	Dyad operator to sill.	6	024516
#7-15 x 7/8" PH FH SS Screw	Dual arm operator to sill.	6	024516
#6 x 5/8" PH FH Black Screw	Tie bar to frame.	8	011636
#7 x 1/2" PH FH Screw	Snubber to frame and sash.	4	013801
#7 x 7/8" PH FH Black Screw	Keepers to stile.	4	011365
#6 x 2-3/4" PH FH Screw	Stationary stops to sash.	As Req'd.	011836
#6 Brass Finishing Washer	Used w/#6 x 2-3/4" screw.	As Req'd.	011835
"C" Hinge Shim	Service item - installed between bottom hinge and sash or bottom track and frame.	As Req'd.	015511
3-3/8" x 1/2" Hinge Shim		As Req'd.	011938
DLX Keeper Locator	Service item.	1	072014

Note: Parts drawings not to scale.

**Screens**

Item #34 Replacement Screens

Glass Size	Bronze	Gold		White	
	Lift Rail Part No.	Lift Rail Part No.	Plunger Part No.	Lift Rail Part No.	Plunger Part No.
11 x 11	N/A	N/A	N/A	N/A	N/A
11 x 15	N/A	N/A	N/A	N/A	N/A
11 x 19	N/A	N/A	N/A	N/A	N/A
11 x 23	N/A	N/A	N/A	N/A	N/A
11 x 27	093734	070093	035039	070141	035052
11 x 31	093735	070094	035040	070142	035053
11 x 35	093736	070095	035041	070143	035054
11 x 43	093737	070096	035042	070144	035055
11 x 47	093738	070118	035043	070166	035056
11 x 55	093739	070119	035044	070167	035057
11 x 59	093740	070120	035045	070168	035058
11 x 67	093741	070100	010286	070149	010290
15 x 11	N/A	N/A	N/A	N/A	N/A
15 x 15	N/A	N/A	N/A	N/A	N/A
15 x 19	093742	070092	022444	070175	N/A
15 x 23	093743	010233	N/A	N/A	N/A
15 x 27	093744	070073	101476	070124	019240
15 x 31	093745	070074	101477	070125	019241
15 x 35	093746	070075	101478	070126	019242
15 x 43	093747	070084	010774	070127	019243
15 x 47	093748	070101	010480	070150	019244
15 x 55	093749	070109	011760	070151	019245
15 x 59	093750	070102	010481	070152	019246
15 x 67	093751	070115	013396	070153	019247
19 x 11	N/A	N/A	N/A	N/A	N/A
19 x 15	N/A	N/A	N/A	N/A	N/A
19 x 19	093752	070091	021046	070145	039380
19 x 23	093753	021803	N/A	010036	N/A
19 x 27	093754	070076	010483	070128	019248
19 x 31	093755	070077	010484	070129	019249
19 x 35	093756	070078	010485	070130	019250
19 x 43	093757	070085	010775	070131	019251
19 x 47	093758	070103	010487	070154	019252
19 x 55	093759	070110	010761	070155	019253
19 x 59	093760	070104	010488	070156	019254
19 x 67	093761	070113	011829	070157	019255

Continued on next page

# Wood Wood Casement Windows Replacement Parts



## Screens

Continued from previous page

### Item #34 Replacement Screens

Glass Size	Bronze		Gold		White	
	Lift Rail Part No.		Lift Rail Part No.	Plunger Part No.	Lift Rail Part No.	Plunger Part No.
23 x 11	N/A		N/A	N/A	N/A	N/A
23 x 15	N/A		N/A	N/A	N/A	N/A
23 x 19	N/A		N/A	N/A	N/A	N/A
23 x 23	093762		010531	N/A	010527	N/A
23 x 27	093763		070029	010490	070132	019256
23 x 31	093764		070080	010491	070133	019257
23 x 35	093765		070081	010492	070134	019258
23 x 43	093766		070086	010776	070135	019259
23 x 47	093767		070105	010494	070158	019260
23 x 55	093768		070111	011762	070159	019261
23 x 59	093769		070106	010495	070160	019262
23 x 67	093770		070116	013397	070161	019263
27 x 11	N/A		N/A	N/A	N/A	N/A
27 x 15	N/A		N/A	N/A	N/A	N/A
27 x 19	N/A		N/A	N/A	N/A	N/A
27 x 23	N/A		N/A	N/A	N/A	N/A
27 x 27	093771		070088	013398	070136	019264
27 x 31	093772		070089	013399	070137	019265
27 x 35	093773		070082	010515	070138	019266
27 x 43	093774		070083	010553	070139	019267
27 x 47	093775		070108	010828	070162	019268
27 x 55	093776		070112	011819	070163	019269
27 x 59	093777		070114	013101	070164	019270
27 x 67	093778		070117	013400	070165	019271
31 x 11	N/A		N/A	N/A	N/A	N/A
31 x 15	N/A		N/A	N/A	N/A	N/A
31 x 19	N/A		N/A	N/A	N/A	N/A
31 x 23	N/A		N/A	N/A	N/A	N/A
31 x 27	N/A		N/A	N/A	N/A	N/A
31 x 31	093779		070090	018151	070140	019280
31 x 35	093780		070098	039533	070147	039540
31 x 43	093781		070099	039534	070148	039541
31 x 47	093782		070121	039535	070169	039542
31 x 55	093783		070122	039536	070170	039543
31 x 59	093784		070123	039537	070171	039544
31 x 67	093785		070107	010556	070172	011371

Wood Wood Casement Windows

